

PINZE SENZA LAVORAZIONE DEL VETRO

CLAMPS WITHOUT GLASS PREPARATION / KLEMMSCHUHE OHNE GLASBEARBEITUNG



100 Kg
x 2pcs

Materiale: **ALLUMINIO PRESSOFUSO**
Material: **DIE CASTED ALUMINIUM**
Material: **GEGOSSENES ALUMINIUM**

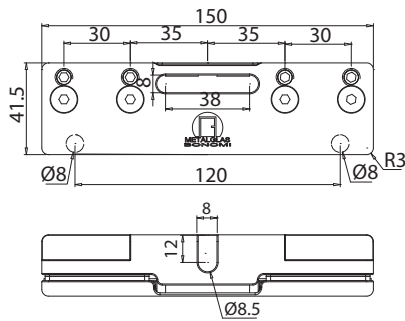

V-108

- Pinza rivoluzionaria che permette in economia grazie ai suoi kit di spessori, compresi, di serrare vetri dal 8 al 12,76 mm. Inoltre grazie ai grani si possono anche serrare vetri con misure variabili, esempio 12,5 - 10,3 - 8,6 mm
- Trail-blazing clamp complete with spacers to tighten 8 to 12.76 mm glass in a cost-effective manner.
- Moreover, the dowels allow tightening glass of variable sizes, for example 12.5 - 10.3 - 8.6
- Revolutionärer Klemmschuh, der es dank den mitgelieferten Unterlage-Kits möglich macht, wirtschaftlich Gläser von 8 bis 12,76 mm zu klemmen. Zudem können danke der Gewindestifte auch Gläser mit variablen Maßen geklemmt werden, zum Beispiel 12,5 – 10,3 – 8,6

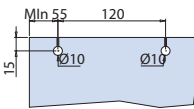
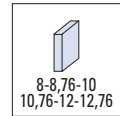

OPTIONAL
Fori di sicurezza
Security holes
Sicherheitsbohrungen

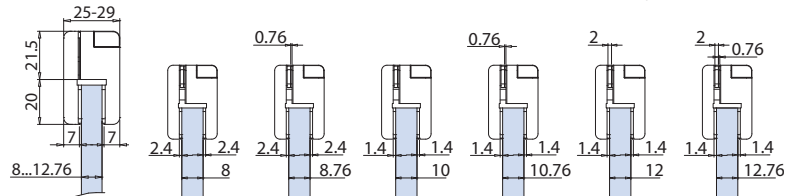

- Spessori inclusi
- Spacers included
- Distanzscheiben enthalten

- Grani per garantire un serraggio ottimale
- Extra screws for a optimal fastening
- Extra Schrauben für ein optimales Anziehen

€ A.589

xme526



80 Kg
x 2pcs

Materiale: **ALLUMINIO TRAFILATO**
Material: **EXTRUDED ALUMINIUM**
Material: **STRANGGEPRESSTES ALUMINIUM**

V-104

- Pinza realizzata principalmente per controtelai a scomparsa, raso parete senza stipiti con le sue velette senza lavorazione del vetro di dimensioni ridotte
- Clamp made to be used mainly with flush pocket systems without frames, with cover profiles, without glass preparation, of limited dimensions
- Klemmschuh, der hauptsächlich für Einbaukastenrahmensysteme hergestellt worden ist, bündig an Wänden ohne Zargen, mit Abdeckblenden, ohne Glasbearbeitung und mit kleinen Abmessungen

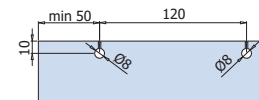
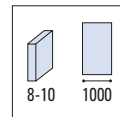
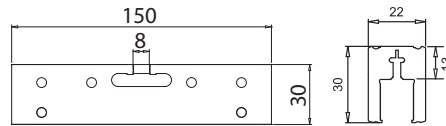

OPTIONAL
Fori di sicurezza
Security holes
Sicherheitsbohrungen

sla39



80 Kg
x 2pcs

Materiale: **ALLUMINIO PRESSOFUSO**
Material: **DIE CASTED ALUMINIUM**
Material: **GEGOSSENES ALUMINIUM**

V-090

- Pinza
- Clamp
- Klemmschuh

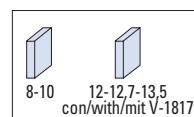
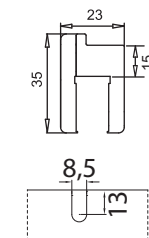

€ A.591

V-1817

- Kit spessori per vetro 12-12,7-13,5 - per 2 pinze V-090 e V-090-T
- Kit spacers for glass thickness 12-12,7-13,5 - for 2 clamps V-090 and V-090-T
- Kit Distanzscheiben für Glasdicke 12-12,7-13,5 - für 2 Klemm-Lauwagen V-090 und V-090-T

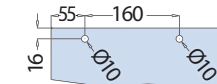
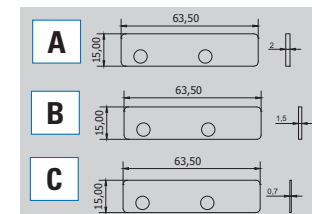

OPTIONAL
Fori di sicurezza
Security holes
Sicherheitsbohrungen

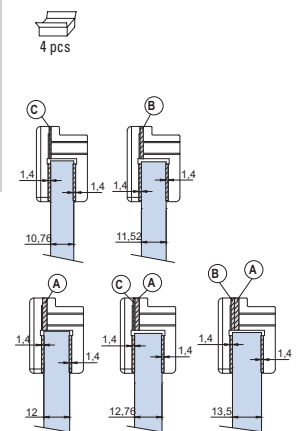

€ A.592



50 Kg
x 2pcs

Materiale: **ALLUMINIO PRESSOFUSO**
 Material: **DIE CASTED ALUMINIUM**
 Material: **GEGOSSENES ALUMINIUM**

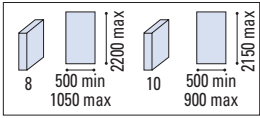

V-1845

- Pinza innovativa senza lavorazione vetro: la più piccola al mondo con i suoi 25 mm di altezza, (la prima vera alternativa alle pinze con lavorazione del vetro per porte a scomparsa).
- Trail-blazing clamp without glass preparation: with a height of 25 mm, it is the smallest in the world (and the first real alternative to clamps with glass preparation for flush sliding doors).
- Innovativer Klemmschuh ohne Glasbearbeitung: der weltweit kleinste mit 25 mm Höhe, (die erste wirkliche Alternative zu Klemmschuhen mit Glasbearbeitung für Einbauschiebetüren).

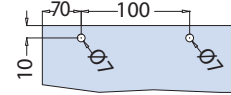
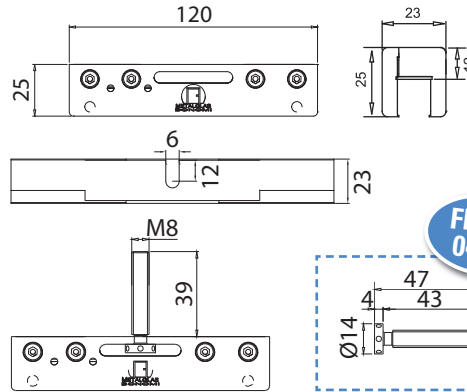

OPTIONAL
 Fori di sicurezza.
 Raccomandati per peso ante > 40 kg
 Security holes.
 Recommended for weight panels > 40 kg
 Sicherheitsbohrungen.
 Empfohlen mit Flügengewicht > 40 kg

FROM 04/20

▶A.593

xme510a

PINZE CON LAVORAZIONE DEL VETRO CLAMPS WITH GLASS PREPARATION / KLEMMSCHUHE MIT GLASBEARBEITUNG



V-011-FU

- Pinza per scorrevole in fusione di alluminio vetro 8/10 mm con fori nel vetro verniciata grigia
- Die casted clamp for glass sliding door 8/10 mm with glass preparation silver lacquered
- Klemmschuh gegossen für Ganzglasschiebetür 8/10 mm Glasdicke mit Glasbohrung, silber lackiert

Materiale: **ALLUMINIO PRESSOFUSO**
 Material: **DIE CASTED ALUMINIUM**
 Material: **GEGOSSENES ALUMINIUM**

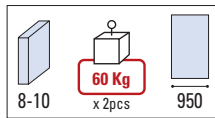

▶A.594

V-011-FR

- Pinza per scorrevole ricavata da materiale pieno, vetro 8/10 mm con fori nel vetro alluminio anodizzato
- Clamp for glass sliding door 8/10 mm with glass preparation aluminium anodised
- Klemmschuh für Ganzglasschiebetür 8/10 mm Glasdicke mit Glasbohrung, EV1

Materiale: **ALLUMINIO TRAFILATO**
 Material: **EXTRUDED ALUMINIUM**
 Material: **STRANGEPRESSTES ALUMINIUM**

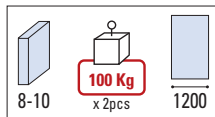

▶A.595

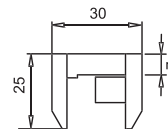
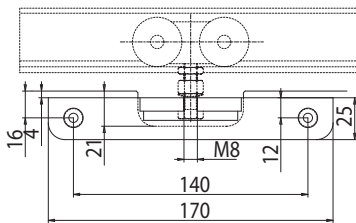
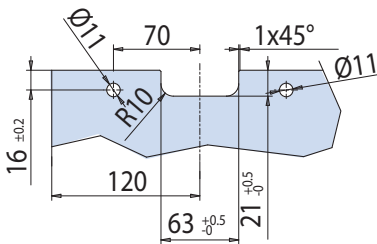

xla39



120 Kg
x 2pcs

Materiale: **ALLUMINIO TRAFILATO**
 Material: **EXTRUDED ALUMINIUM**
 Material: **STRANGEPRESSTES ALUMINIUM**

V-010

- Pinza per scorrevole vetro 8/10 mm senza fori
- Clamp for sliding door 8/10 mm without holes
- Klemmschuh für Ganzglasschiebetür 8/10 mm ohne Glasbearbeitung (Bohrungen, Fräsungen)

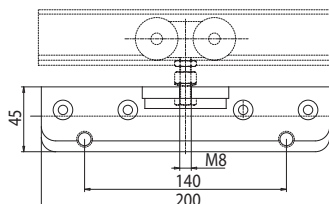
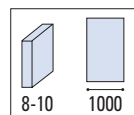
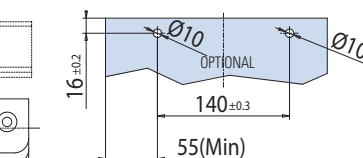

OPTIONAL
 Fori di sicurezza
 Security holes
 Sicherheitsbohrungen

xla39

159



80 Kg
x 2pcs

Materiale: ZAMA
Material: ZAMAK
Material: ZAMAK

V-006

- Come la V-011, pinza adatta per porte a scomparsa con controtelai standard. Grazie alla sua innovativa lavorazione del vetro basta fare solo una tacca nel vetro al posto della tacca più fori della V-011
- Like the V-011, this clamp is suitable for flush sliding doors with standard pocket systems. Thanks to its innovative glass preparation, you only need one notch in the glass instead of the notch plus holes needed with the V-011
- Wie der V-011, ist der Klemmschuh für Einbauschiebetüren mit Standard-Kastenrahmen geeignet. Dank der innovativen Glasbearbeitung reicht nur eine Kerbe im Glas aus, im Gegensatz zum V-011, wo eine Kerbe plus Bohrungen notwendig sind

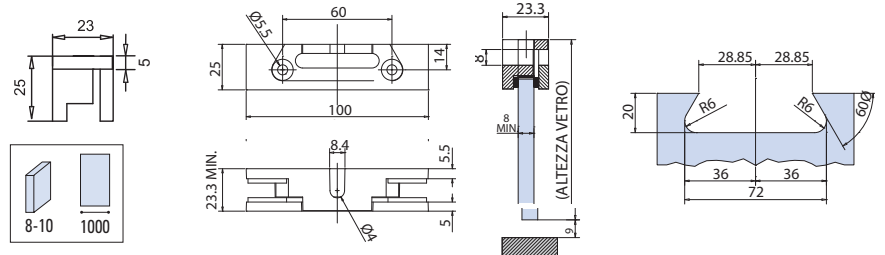

€▶A.596



Materiale: ZAMA
Material: ZAMAK
Material: ZAMAK

V-007

- Paio copertine optional per pinza V-006
- Pair optional covers for clamp V-006
- Paar optional Abdeckungen für Klemmschuh V-006
CP - NS

€▶A.597

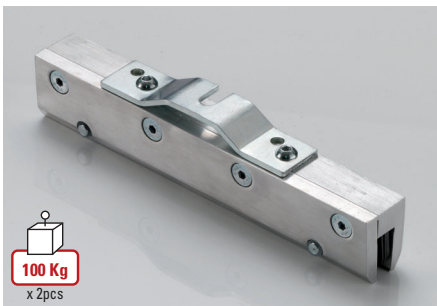

100 Kg
x 2pcs

Materiale: ALLUMINIO TRAFILATO
Material: EXTRUDED ALUMINIUM
Material: STRANGGEPRESSTES ALUMINIUM

V-009

- Pinza per scorrevole vetro 8/10 mm senza fori nel vetro
- Clamp for glass sliding door 8/10 mm without holes
- Klemmschuh für Schiebetür 8-10mm, ohne Bohrungen

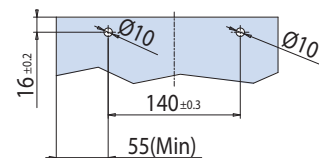
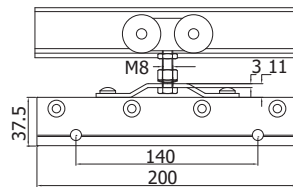
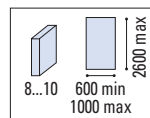

OPTIONAL
Fori di sicurezza
Security holes
Sicherheitsbohrungen

xme335 / xla39

€▶A.599



100 Kg
x 2pcs

Materiale: ALLUMINIO TRAFILATO
Material: EXTRUDED ALUMINIUM
Material: STRANGGEPRESSTES ALUMINIUM

V-008

- Pinza per scorrevole vetro 8/10 mm senza fori nel vetro
- Clamp for glass sliding door 8/10 mm without glass preparation
- Klemmschuh für Schiebetür 8-10mm, ohne Bohrungen

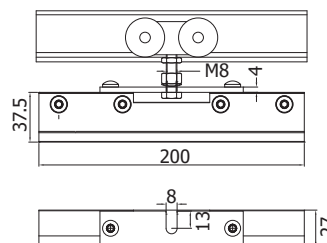
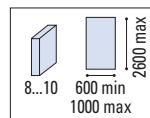

€▶A.598

xme335