



INVISIBILE TELESCOPICO SINCRO



V-7300

TRASCINAMENTO SINCRO CON CINGHIA
SINCRO DRAGGING SYSTEM WITH TOOTHED BELT
SINCRO MITNEHMER KIT MIT ZAHNRIEMEN

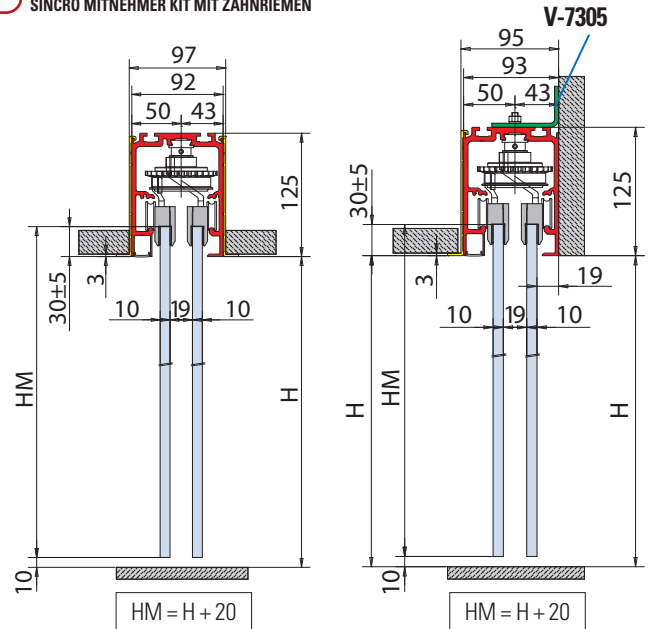
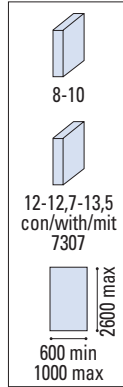

V-7300 SET 1 €▶A.484

- Sistema per 2 ante scorrevoli telescopiche con possibilità di vetro fisso, con kit di trascinamento, fissaggio a soffitto
- Telescopic sliding door system 2-ways and optional fixed panel, with dragging mechanism, ceiling installation
- Teleskopisches Schiebetürsystem 2-läufig mit optional Seitenteil, mit Mitnehmer Kit, Deckenmontage

V-7300 SET 1 • Soffitto • Ceiling • Decke

V-7300 SET 2 • Parete • Wall • Wand

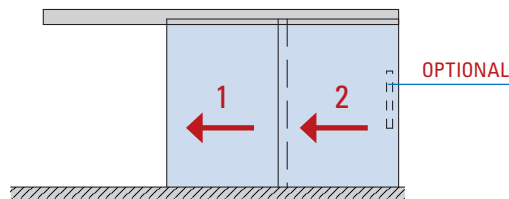

V-7300 SET 2 €▶A.485

- Sistema per 2 ante scorrevoli telescopiche con possibilità di vetro fisso, con kit di trascinamento, fissaggio a parete
- Telescopic sliding door system 2-ways and optional fixed panel, with dragging mechanism, wall installation
- Teleskopisches Schiebetürsystem 2-läufig mit optional Seitenteil, mit Mitnehmer Kit, Wandmontage

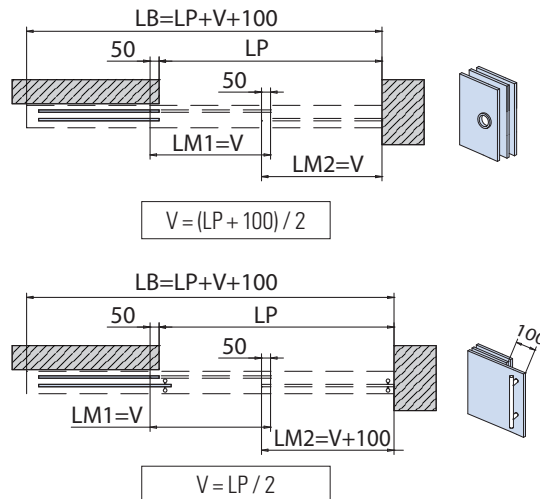

COMPONENTI / COMPONENTS / EINZELTEILE ▶ 136

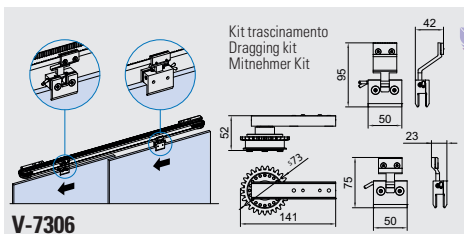
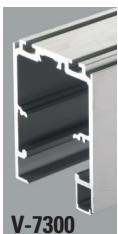

OPTIONAL		• Guarnizioni per sede vetro fisso • Gaskets for fixed glass • Dichtungen für Seitenteil
VP-019-MT	VP-018-MT	
1000 mm		
2000 mm		
3000 mm		

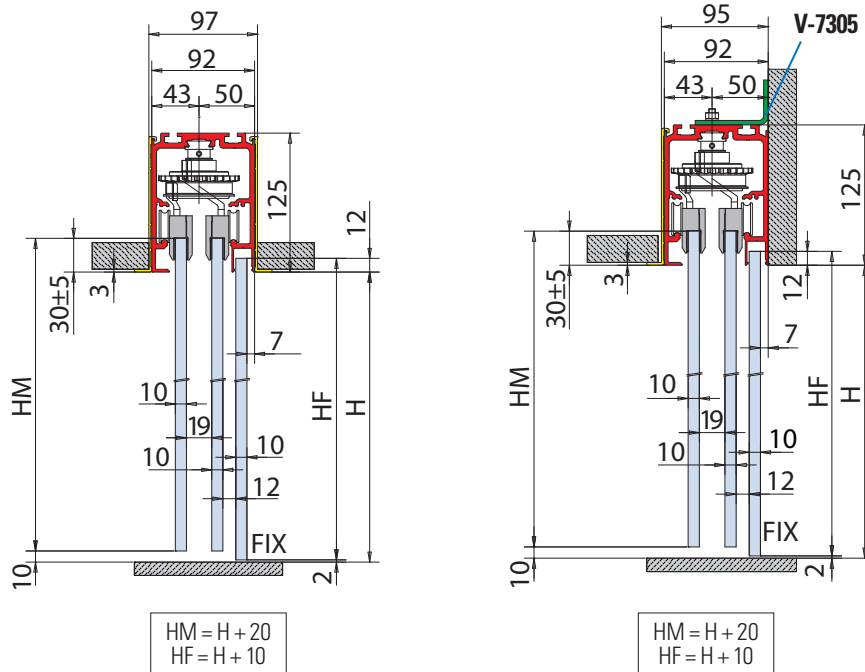

V-7300 SET 1 • Soffitto • Ceiling • Decke

V-7300 SET 2 • Parete • Wall • Wand

Con vetro fisso / With fixed panel / Mit Seitenteil

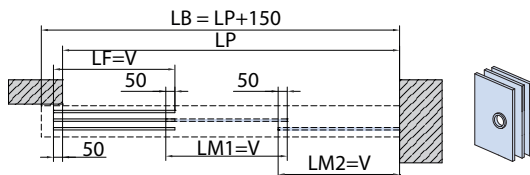
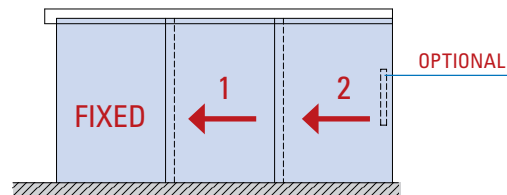

$$V = (LP + 150) / 3$$

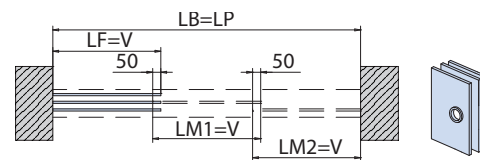

$$V = (LP + 100) / 3$$

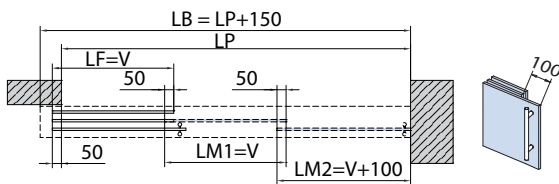

$$V = (LP + 50) / 3$$

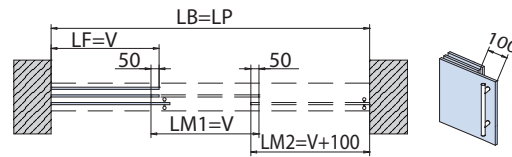

$$V = LP / 3$$

xla350 / xla369b

TELESCOPIC

Cod.	Fin. / Fin. / Oberf.	V-7300 SET 1 FIX	V-7300 SET 1-MIS	V-7300 SET 2 FIX	V-7300 SET 2-MIS
V-7300 LB=2000 LB=3000 LB=4000 LB=6000	AN	1	-	1	-
V-7300-MIS L = 1500→6000	AN	-	1	-	1
V-7202	-	1	1	1	1
V-7306	-	1	1	1	1
V-7305 Staffa / Bracket / Winkelverbinder (OPTIONAL)		-	-	(1 x 400 mm)	(1 x 400 mm)

INVISIBILE TELESCOPICO SINCRO

COMPONENTI / COMPONENTS / EINZELTEILE

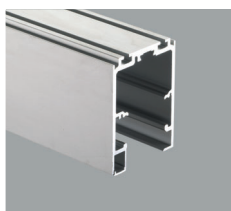

V-7300

€▶A.486

- Binario telescopico Invisibile per 2 ante scorrevoli con vetro fisso laterale
- Telescopic track profile Invisibile for sliding panels and fixed side panel
- Laufschiene Teleskopisch Invisibile für Schiebetüren und Seitenteil

AN

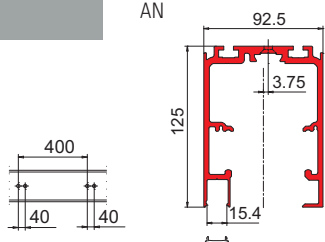

xfb-071



V-7202

€▶A.487

- Set accessori per 2 ante scorrevoli "Invisibile doppio":
4 carrelli morsetti per vetro 8-10 mm, 4 stopper
- Accessory set for 2 "Invisibile doppio" sliding panels:
4 roller carriers for glass 8-10 mm, 4 endstops
- Zubehör Set für 2 "Invisibile doppio" Schiebetüren:
4 klemm-Laufwagen für Glas 8-10 mm, 4 Stopper

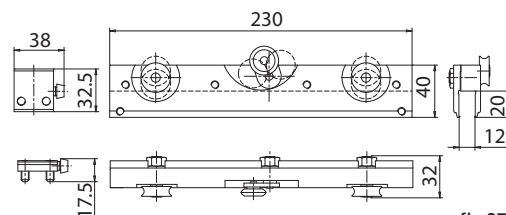
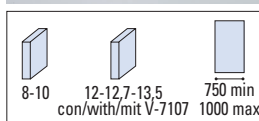

xfb-070

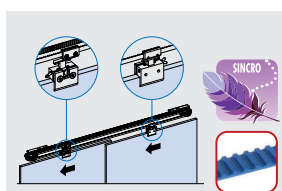

V-7306

€▶A.488

- Kit morsetti trascinamento SINCRO 2 ante scorrevoli compreso di guide a pavimento V-012-B e V-099-C
- Dragging kit for SINCRO 2 sliding panel, with floor guides V-012-B and V-099-C
- Mitnehmer Kit SINCRO für 2 bewegliche Schiebetüren mit Bodenführungen V-012-B und V-099-C

V-099-C

V-012

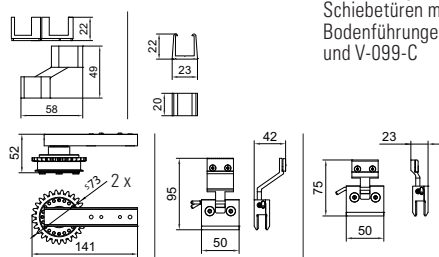

xla-369d / xfb-071



V-099-C DX / V-099-C SX

- Doppia guida a pavimento destra o sinistra
- Double floor guide right or left
- Doppel Bodenführung rechts oder links

€▶A.469

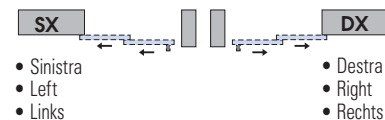
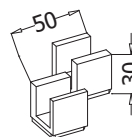

xme425t

OPTIONAL	
VP-019-MT	VP-018-MT
2	3
1000 mm	
2000 mm	
3000 mm	
<ul style="list-style-type: none"> • Guarnizioni per sede vetro fisso • Gaskets for fixed glass • Dichtungen für Seitenteil 	
8	10
10	12

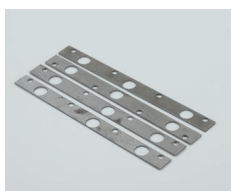

V-7307

€▶A.489

- Set per spessori vetro 12 - 12,7 - 13,5 (per 2 pinze V-7202)
- Set spacers for glass thickness 12 - 12,7 - 13,5 (for 2 clamps V-7202)
- Set distanzscheiben für Glasdicke 12 - 12,7 - 13,5 (für 2 Klemm-Laufwagen V-7202)

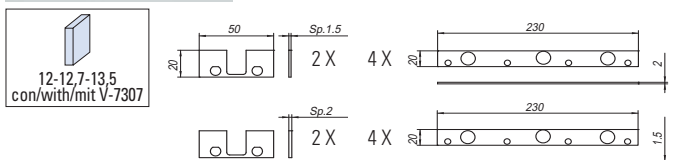

xla-369d



V-2015-MIX

€▶A.641

- Canalina per vetro fisso (non compresa nel V-2000) - sfusa, compresa di guarnizioni
- U-channel for fixed panel(not included in V-2000) - complete with gaskets
- U-profil mit Dichtungen für Seitenteil (nicht enthalten in V-2000) Oberfläche: ev1

AN

Cod.	Fin./Fin./Oberf.
V-2015-2000 mm	AN
V-2015-3000 mm	AN
V-2015-6000 mm	AN

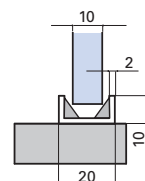

V-2015

V-2014-MIX

- Canalina per vetro fisso escluso guarnizioni
- U channel for fixed panel, gaskets not included
- U Profil für Seitenteil Dichtungen nicht inkl.

AN - IXE

€▶A.477

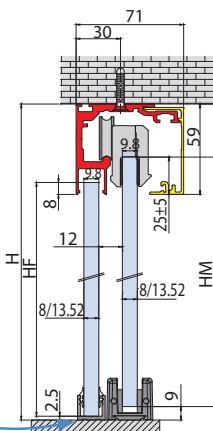
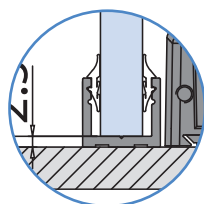

- Profilo da infilare
- Insert profile
- Profil durchziehen

- Guarnizioni
- Gaskets
- Dichtungen

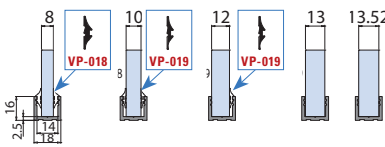

Cod.	Fin./Fin./Oberf.
V-2014-2000 mm	AN / IXE / NO
V-2014-3000 mm	AN / IXE / NO
V-2014-6000 mm	AN / IXE / NO

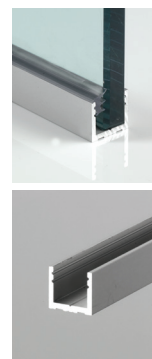

FB044-E