

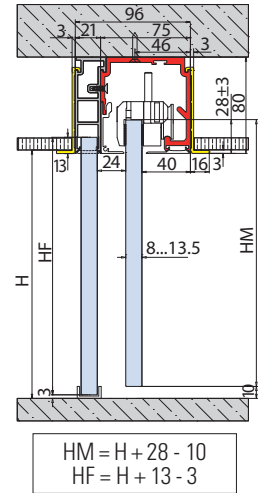

INVISIBLE (OPTIONAL SOFT-CLOSE)

V-7103

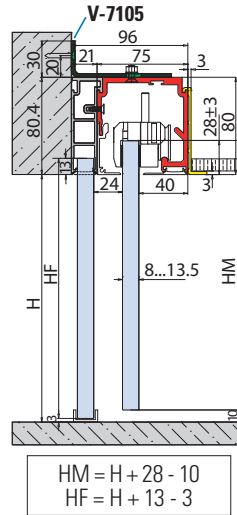
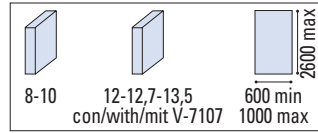

INVISIBLE

V-7103 SET 1

€▶A.200

- Set per 1 anta scorrevole e vetro fisso, fissaggio a parete/soffitto
- Sliding door set with fixed panel, wall/ceiling installation
- Schiebetürset 1-flügelig mit Seitenteil, Wand-Deckenmontage

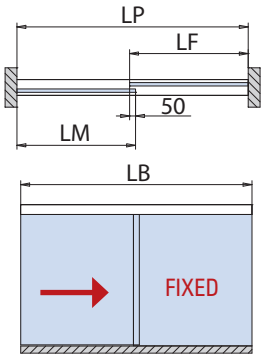

$$LB = LP$$

$$LM = LF = (LP + 50) / 2$$

V-7103 SET 2

€▶A.201

- Set per 2 ante scorrevole e vetri fissi, fissaggio a parete/soffitto
- Sliding doors set with fixed panels, wall/ceiling installation
- Schiebetürset 2-flügelig mit Seitenteile, Wand-Deckenmontage

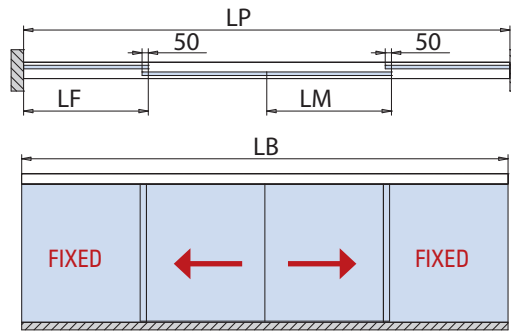

$$LB = LP$$

$$LM = LF = (LP + 100) / 4$$

LAVORAZIONE VETRO GLASS PREPARATION GLASBEARBEITUNG

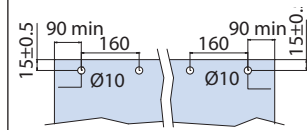

- Fori **optional**
- Holes **optional**
- Bohrungen **optional**

xme346

COMPONENTI / COMPONENTS / EINZELTEILE ▶ 82



OPTIONAL	
VP-019-MT	VP-018-MT
2	3
1000 mm	
2000 mm	
3000 mm	

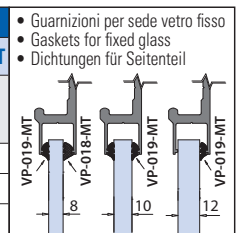

Cod.	Fin. / Fin. / Oberf.	V-7103 SET 1 FIX	V-7103 SET 1-MIS	V-7103 SET 2 FIX	V-7103 SET 2-MIS
V-7101 L=2000 L=3000 L=4000 L=6000	AN	1	-	1	-
V-7101-MIS L=1500 → 6000	AN	-	1	-	1
V-7104 L=2000 L=3000 L=4000 L=6000	AN	1	-	1	-
V-7104-MIS L=1500 → 6000	AN	-	1	-	1
V-7102	-	1	1	2	2
V-012-INS	AN	1	1	2	2
V-7108 Soft-close (OPTIONAL)	-	(1)	(1)	(2)	(2)
V-7105 Staffa / Bracket / Winkelverbinder (OPTIONAL)	-	(1 x 400 mm)	(1 x 400 mm)	(1 x 400 mm)	(1 x 400 mm)

V-7100 / V-7103 INVISIBLE (OPTIONAL SOFT-CLOSE)

COMPONENTI / COMPONENTS / EINZELTEILE

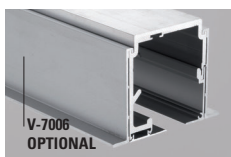

V-7101

- Binario Invisibile
- Track profile Invisible
- Laufschiene Invisibile

AN

€▶A.202

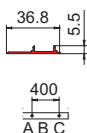

V-7006-CF2

- Profilo per V-7101 con appoggio per controsoffitto
- Profile for V-7101 with support for suspended ceiling
- Profil für V-7101 mit Auflage für Abhängter Decke

AN

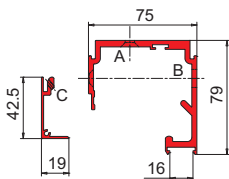
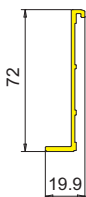

xfb-069

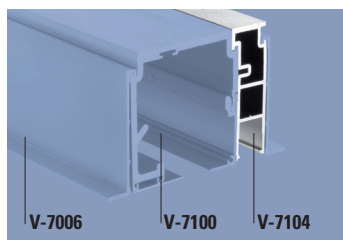

V-7104

- Profilo per vetro fisso per V-7101
- Side panel profile for V-7101
- Seitenteilprofil für V-7101

AN

€▶A.203

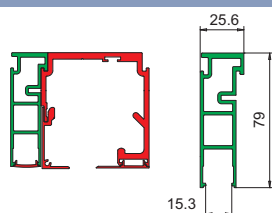

xfb-069

OPTIONAL €▶A.210

VP-019-MT	VP-018-MT
2	3
1000 mm	
2000 mm	
3000 mm	
<ul style="list-style-type: none"> • Guarnizioni per sede vetro fisso • Gaskets for fixed glass • Dichtungen für Seitenteil 	
8	10
10	12



V-7108

- Optional Soft-close

€▶A.207

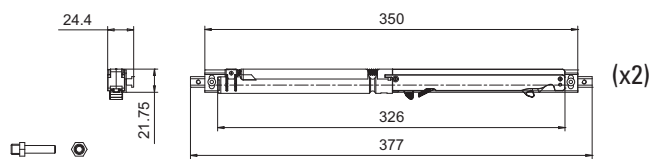

xfb-069



V-7107

- Set per spessori vetro 12 - 12,7 - 13,5 (per 2 pinze V-7102)
- Set spacers for glass thickness 12 - 12,7 - 13,5 (for 2 clamps V-7102)
- Set distanzscheiben für Glasdicke 12 - 12,7 - 13,5 (für 2 Klemm-Lauwagen V-7102)

€▶A.206

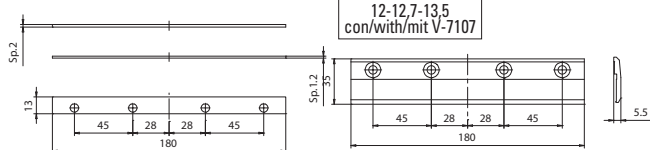

xfb-069

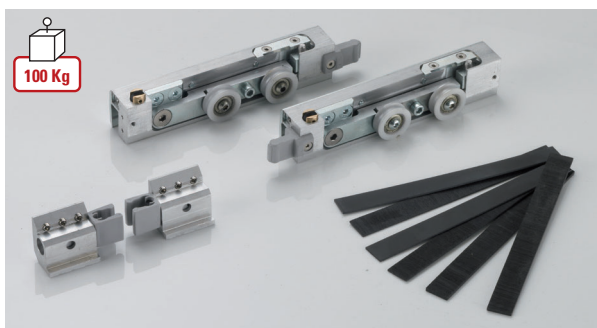

V-7102

- Set carrelli con pinze e stopper per 1 anta scorrevole
- Set roller carriers and stoppers for 1 panel
- Set Klemm-Laufwagen und stopper für 1 Flügel

€▶A.205

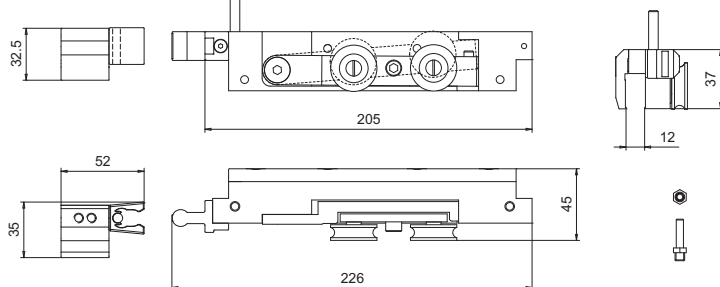

xfb-069

8-10	12-12,7-13,5	600 min 2600 max
con/with/mit V-7107		

V-2014-MIX

- Canalina per vetro fisso escluso guarnizioni
- U channel for fixed panel, gaskets not included
- U Profil für Seitenteil Dichtungen nicht inkl.

Cod.	Fin. / Fin. / Oberf.
V-2014-2000 mm	AN / IXE
V-2014-3000 mm	AN / IXE
V-2014-6000 mm	AN / IXE

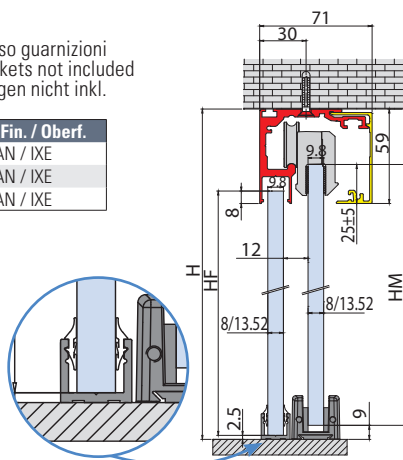

€▶A.196

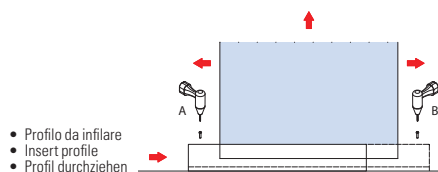

- Profilo da infilare
- Insert profile
- Profil durchziehen

- Guarnizioni
- Gaskets
- Dichtungen

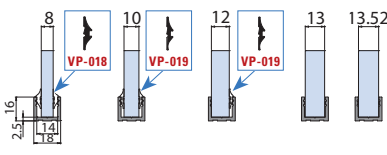

FB044-E