

# BRIXIA 50 SOFT-CLOSE

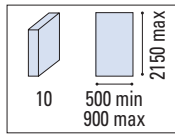

**V-1840**

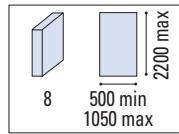

SIMPLE

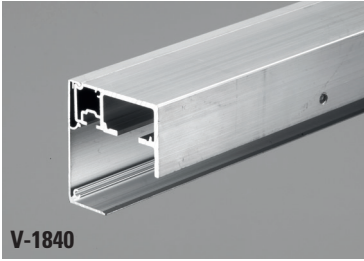

## COMPONENTI / COMPONENTS / EINZELTEILE ▶ 50

**V-1840**

**V-1842**

50 Kg

**V-1846-50** 50 Kg

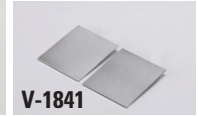
**V-012**

**V-1841**

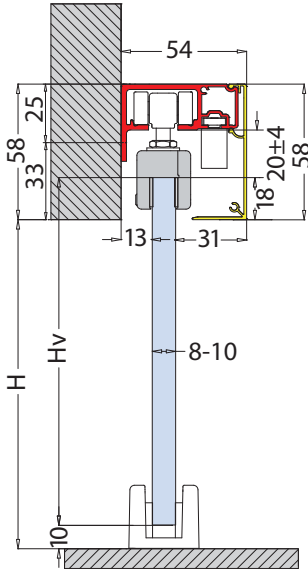
SIMPLE



$$HV = H + 8$$

**V-1840 SET 1**

€▶A.156

- Set per 1 anta scorrevole, fissaggio a parete
- Sliding door set, wall installation
- Schiebetürset 1-flügelig, Wandmontage

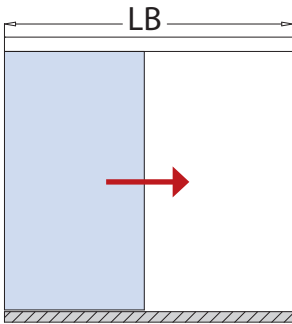
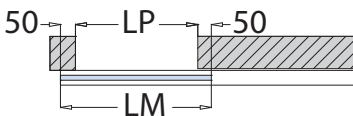

$$LB = LP \times 2 + 150$$

$$LM = LP + 100$$

**V-1840 SET 2**

€▶A.157

- Set per 2 ante scorrevoli, fissaggio a parete
- Sliding doors set, wall installation
- Schiebetürset 2-flügelig, Wandmontage

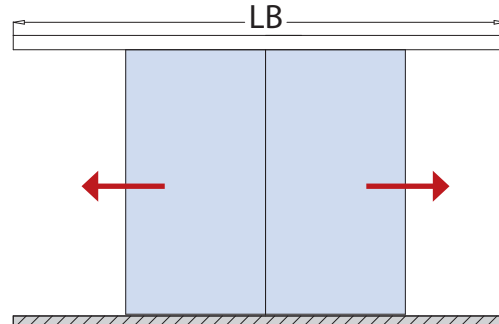
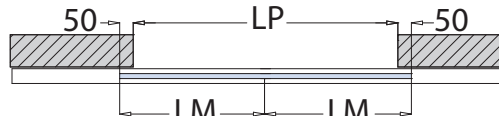

$$LB = LP \times 2 + 100$$

$$LM = (LP + 100) / 2$$

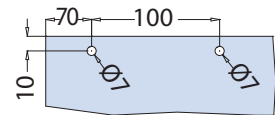
 LAVORAZIONE VETRO  
 GLASS PREPARATION  
 GLASBEARBEITUNG

OPTIONAL (x 2)

- Optional fori sicurezza. Raccomandati per peso ante > 40 kg
- Optional security holes. Recommended for weight panels > 40 kg
- Optional Sicherheitsbohrungen. Empfohlen mit Flügengewicht > 40 kg

xme510

Cod.	Fin. / Fin. / Oberf.	V-1840 SET 1 FIX	V-1840 SET 1 MIS	V-1840 SET 2 FIX	V-1840 SET 2 MIS
<b>V-1840</b> L=2000 L=3000 L=4000 L=6000	AN / IXE	1	–	1	–
<b>V-1840-MIS</b> L=1500 → 6000	AN / IXE	–	1	–	1
<b>V-1842</b>	–	1	1	2	2
<b>V-1846-50</b> 50 Kg	–	1	1	2	2
<b>V-1841</b>	AN / IXE	1	1	1	1
<b>V-012</b>	AN / NS	1	1	2	2

# V-1840 BRIXIA 50 SOFT-CLOSE

## COMPONENTI / COMPONENTS / EINZELTEILE



€▶A.158

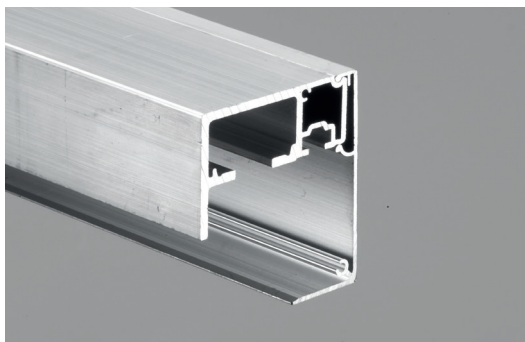

### V-1840

- Guida di scorrimento Brixia 50 completa di veletta
  - Track profile Brixia 50 with cover profile
  - Führungsschiene Brixia 50 mit Profilabdeckung
- AN-IXE

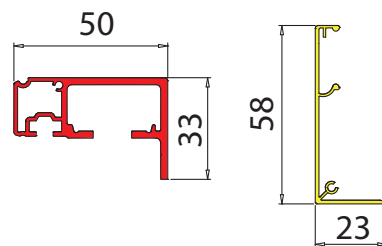

Cod.	Fin./Fin./Oberf.
V-1840-2000 mm	AN / IXE
V-1840-3000 mm	AN / IXE
V-1840-4000 mm	AN / IXE
V-1840-6000 mm	AN / IXE
V-1840-MIS*	AN / IXE

\* disponibilità taglio a misura mm 1500→6000  
\* cut to size mm 1500→6000  
\* nach Mass geschnitten mm 1500→6000

xme510

SIMPLE

€▶A.159

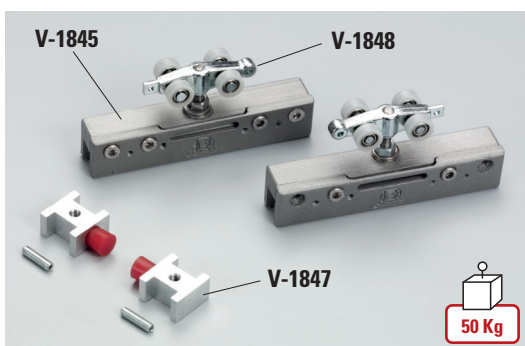

### V-1842

- Set accessori per 1 anta scorrevole composto da 2 carrelli, morsetti per vetro 8-10 mm, 2 stoppers
- Accessories set for 1 sliding panel consisting of N°2 trolley hangers with clamp carriage for 8/10 mm glass, N°2 endstops
- Zubehör für 1 Schiebetür bestehend aus: n° 2 Klemm - Laufwagen für 8/10 mm Glas, n° 2 Stopper

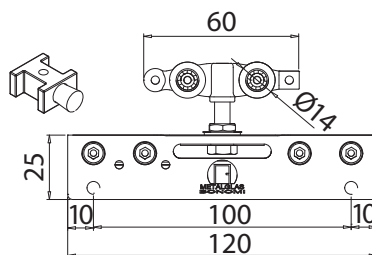

xme510

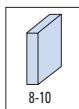

€▶A.160

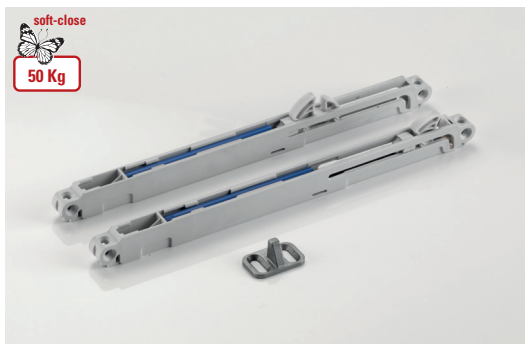

### V-1846-50

- Set 2 stoppers Soft-close (per 1 anta)
- Set 2 stoppers Fifty Soft-close (for 1 sliding panel)
- Set 2 Stoppers Soft-close mit Selbsteinzug (für 1 Schiebetür)

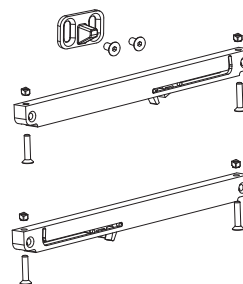
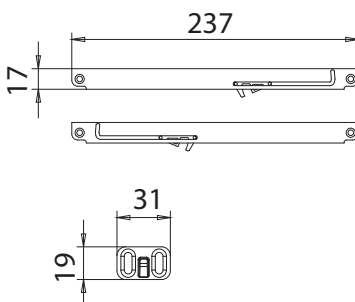

xme508d

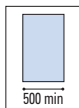

€▶A.162

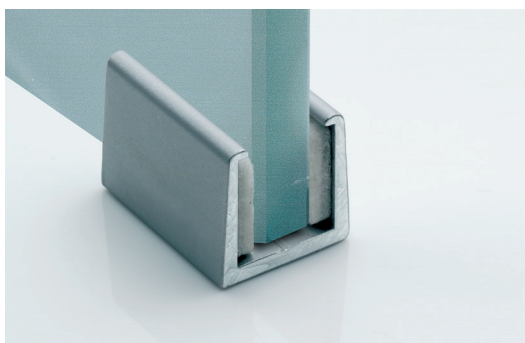

### V-012

- Guida a pavimento per scorrevole con feltrini per vetro 8 e 10 mm
  - Floor guide with felt strips for glass sliding door a 8 and 10mm
  - Bodenführung mit Filzgleiter für Glas 8 und 10 mm
- AN - NS

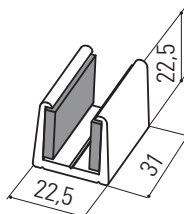

- Altri modelli disponibili a pag. 174
- Other models available on page.174
- Weitere Modelle auf Seite 174

V-012

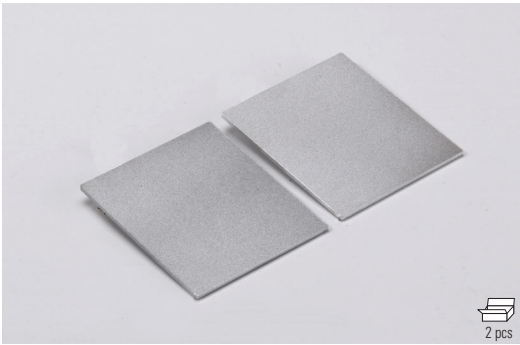
**V-1841**

- Paio tappi finali per binario V-1840
  - Pair endcaps for track profile V-1840
  - Paar Endkappen für Laufschienenprofile V-1840
- AN - IXE

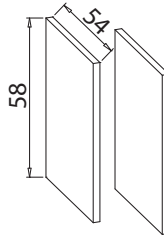

2 pcs



SIMPLE

xme510

**V-1848**

- Carrello Brixia 50
- Carrier Brixia 50
- Laufwagen Brixia 50

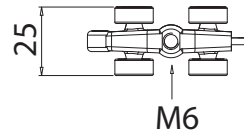
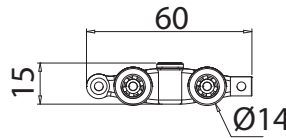

xme510a



**V-1845**

- Pinza per vetro 8/10 mm
- Clamp for sliding door 8/10 mm without holes
- Klemmschuh für 8/10 mm Glas

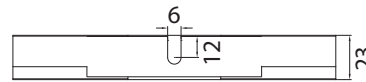
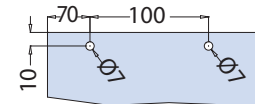
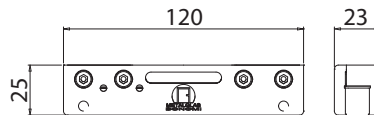
- **Optional fori sicurezza.**  
Raccomandati per peso ante > 40 kg
- **Optional security holes.**  
Recommended for weight panels > 40 kg
- **Optional Sicherheitsbohrungen.**  
Empfohlen mit Flügelgewicht > 40 kg

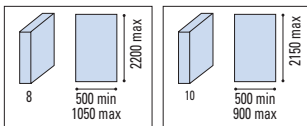

50 Kg  
x 2 pcs

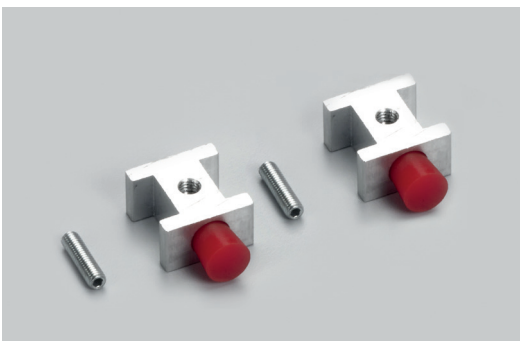

xme510a

**V-1847**

- Coppia stopper Brixia 50
- Pair stoppers Brixia 50
- Paar stoppers Brixia 50

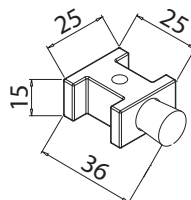

xme510a