

PA-500 PARK do-it-yourself

SCORREVOLI A PARCHEGGIO / SLIDING STACKING SYSTEMS / GANZGLAS-SCHIEBEWANDSYSTEME

MY METALGLAS

€ C.77

SCORREVOLI A PARCHEGGIO
SLIDING STACKING SYSTEMS



- Sistema scorrevole a parcheggio con profili fermavetro continui a misura standard (mm 1000 da tagliare secondo necessità (a carico del cliente), completi di catenaccioli ferma-anta a posizionamento esterno regolabile. Vantaggi di una consegna più veloce e di un unico prodotto a magazzino per tutte le misure fino a 1000 mm.
- Modular sliding stacking system with continuous glass fixing profiles of a standard size (mm 1000) to be cut on the basis of client's requirements comes equipped with an adjustable door holding latch positioned externally. The advantage of this product is quick delivery and a unique product available in the warehouse for all sizes up to 1000 mm.
- Schiebesystem mit Parkraum, durchgehenden Laufschiene-Profilen in Standardgröße (1000 mm), ablängbar, komplett mit äußeren einstellbaren Riegeln zur Flügelbefestigung. Vorteile einer raschen Lieferung und eines einzigen lagermäßigen Produktes mit Abmessungen bis 1000 mm.

- Vantaggi di una consegna più veloce e di un unico prodotto a magazzino per tutte le misure fino a 1000 mm.
- The advantage of this product is quick delivery and a unique product available in the warehouse for all sizes up to 1000 mm.
- Vorteile einer raschen Lieferung und eines einzigen lagermäßigen Produktes mit Abmessungen bis 1000 mm.

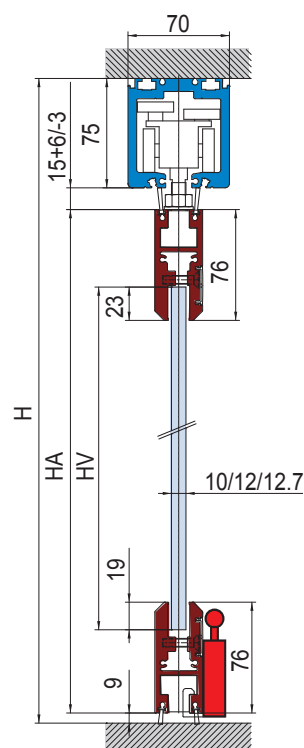

HV = H - 210
HA = H - 100

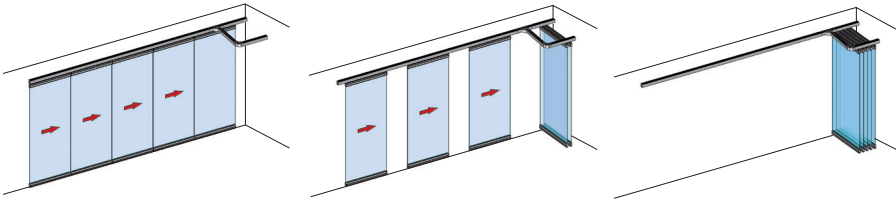

10-12-12,7	120 Kg	Porta laterale Lateral door Dreh-EndFlügel	3200 550 min 1000 max

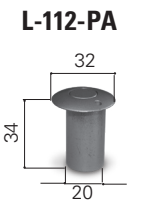
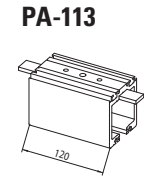
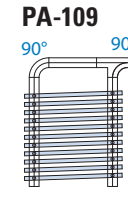
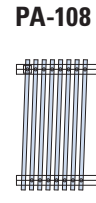
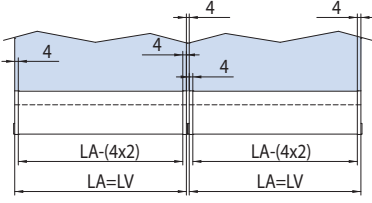
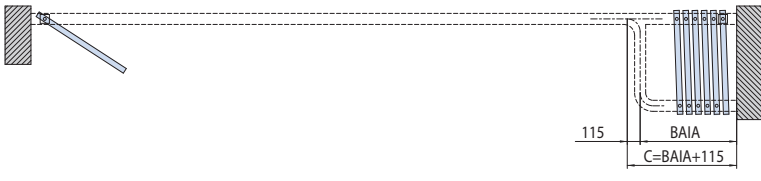

- Baie da ordinare a parte oltre alle ante, altre baie disponibili da pag. 60
- To be ordered separately from the panels, other parking bays available from page 60
- Neben den Flügel extra zu bestellen, andere Parkräume auf Seite 60

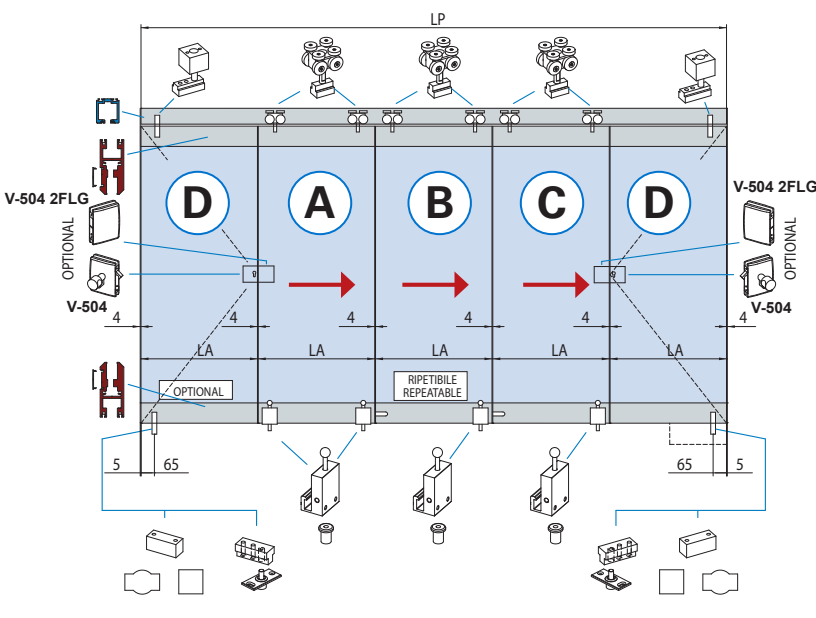

- Calcolo vetro
 - Calculation glass
 - Glasberechnung
- At = 4 x (N + 1)
X = LP - At
X = N x LA
LA = LV = X / N

- D**
 - Porta laterale fissa
 - Lateral fixed door
 - Dreh Flügel
- A**
 - Prima anta
 - First panel
 - Erster Schiebeflügel
- B**
 - Anta intermedia
 - Intermediate panel
 - Zwischen-Schiebeflügel
- C**
 - Ultima anta
 - Last panel
 - End-Schiebeflügel

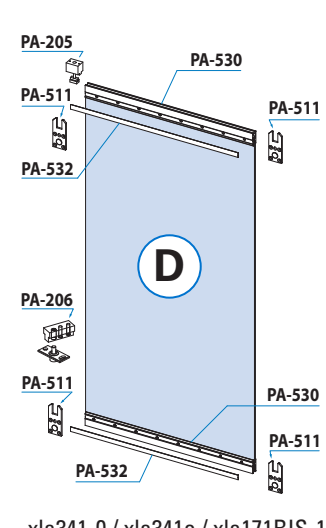
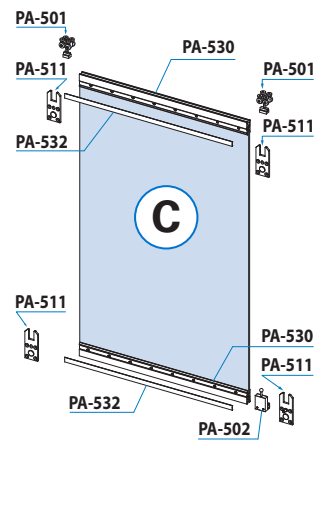
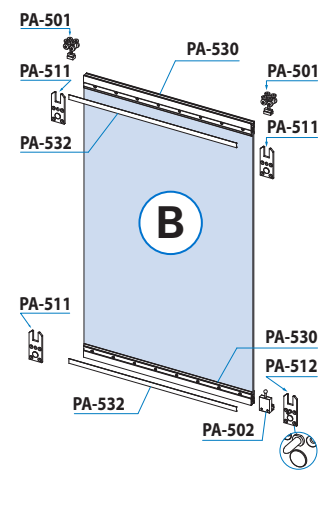
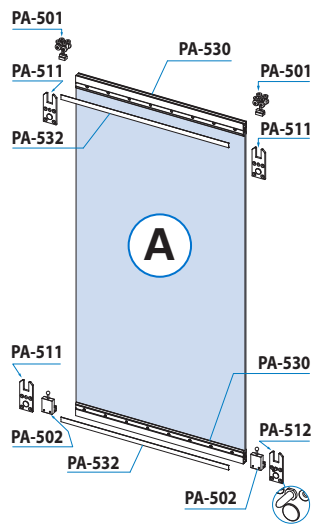

xla341-0 / xla341e / xla171BIS-1

AN Alluminio anodizzato Aluminium anodized Aluminium Silberfarbig	At Arie totali Total clearances Summe alle Abstände Glas/Wand	N Numero ante Numbers panels Anzahl der Elemente	LP Passaggio luce Clear opening width Lichte Durchgangsbreite	LA = LV Larghezza ante = Larghezza vetro Panel width = Glass width Flügelbreite = Glasbreite	H Altezza passaggio luce Clear opening height Lichte durchgangshöhe	HV Altezza vetro Glass height Glashöhe	HA Altezza anta Door height Tür Höhe
---	---	--	---	--	---	--	--

PA-500 PARK do-it-yourself

COME USARE **MY METALGLAS** / HOW TO USE **MY METALGLAS** / WIE MAN BENUTZT **MY METALGLAS**

1 INSERIRE LE MISURE DEL TUO VANO E LE ANTE DESIDERATE
ENTER THE MEASUREMENTS OF YOUR OPENING AND THE DOORS YOU REQUIRE
GEBEN SIE DIE MASSE IHRER ÖFFNUNG EIN UND DIE ERFORDERLICHEN TÜREN

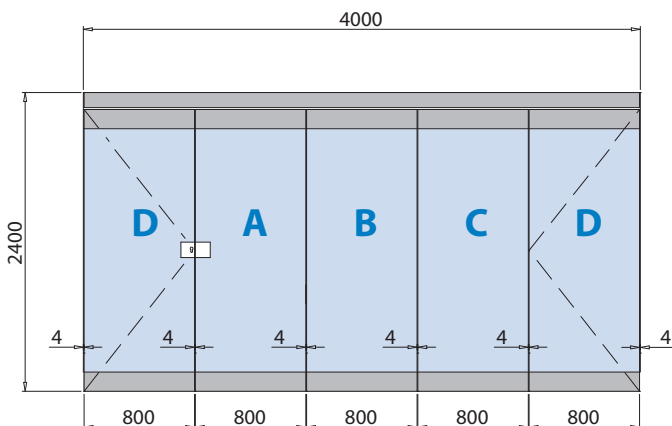

2 SI OTTENGONO LE MISURE DEI VETRI AUTOMATICAMENTE
THE MEASUREMENTS OF THE GLASS WILL BE GENERATED AUTOMATICALLY
DIE ABMESSUNGEN DES GLASES WERDEN AUTOMATISCH BERECHNET

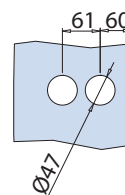
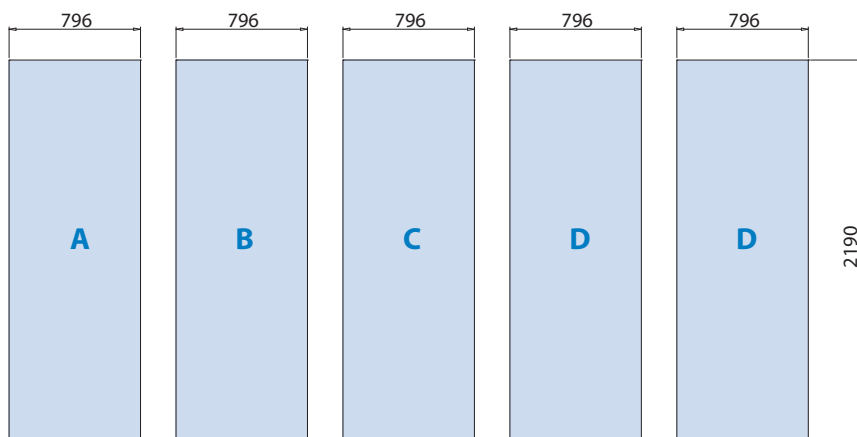

- Foratura vetro porta battente per serrature optional
- Glass preparation pivot door for optional locks
- Glasbearbeitung Dreh-Flügel für optionale Schlösser

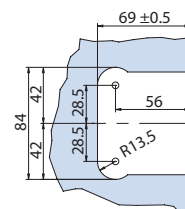

- Foratura vetro porta battente per serrature optional V-504, V-505, V-518, V-519, V-520
- Glass preparation pivot door for optional locks V-504, V-505, V-518, V-519, V-520
- Glasbearbeitung Dreh-Flügel für optionale Schlösser V-504, V-505, V-518, V-519, V-520

3 SI OTTENGONO LE DISTINTE DI TAGLIO DEI PROFILI, DA ABBINARE AGLI ACCESSORI
THE CUTTING SPECIFICATIONS OF THE PROFILES ARE OBTAINED, FOR MATCHING WITH THE ACCESSORIES
SIE ERHALTEN EINE SPEZIFIKATION DER PROFILLÄNGEN ZUM ABGLEICHEN MIT DEM ZUBEHÖR

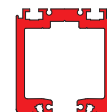
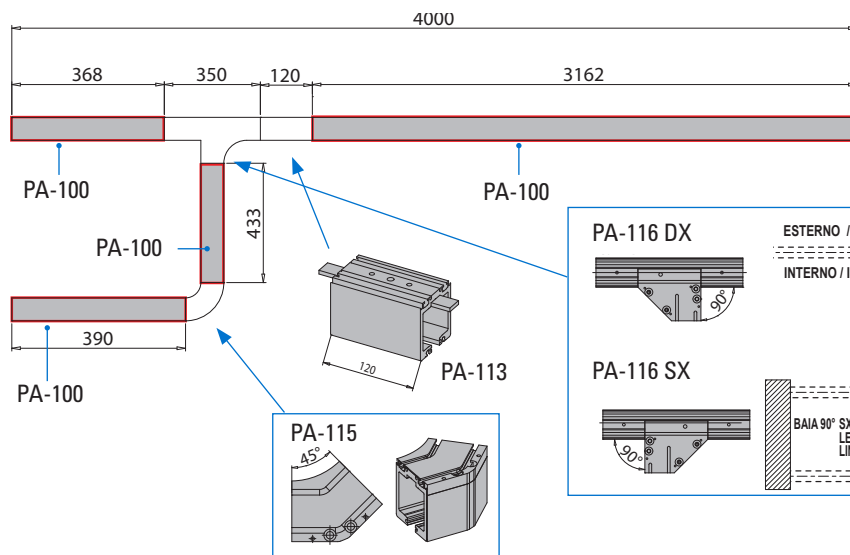

PA-100

PA-500 PARK do-it-yourself

COME ASSEMBLARE LE ANTE / HOW TO ASSEMBLE THE DOORS / WIE DIE TÜREN ZUSAMMENSETZT WERDEN

TAGLIO PROFILI PROFIL PREPARATION / PROFILBEARBEITUNG		KIT ACCESSORI ACCESSORY SETS / ZUBEHÖR SETS		ANTA COMPLETA COMPLETE DOOR / KOMPLETTE TÜR
--	--	--	--	--

ANTA A / DOOR A / TÜR A

PA-530 (x 2)

PA-532 (x 4)

SUPERIORE + INFERIORE
 / TOP + BOTTOM / OBEN + UNTEN

PA-500 ANTA A-10 (for glass 10 mm)
PA-500 ANTA A-12 (for glass 12 - 12,7 mm)
 PRIMA ANTA A
 FIRST PANEL A
 ERSTER SCHIEBEFLÜGEL A

SCORREVOLI A PARCHEGGIO
 SLIDING STACKING SYSTEMS

ANTA B / DOOR B / TÜR B

PA-530 (x 2)

PA-532 (x 4)

SUPERIORE + INFERIORE
 / TOP + BOTTOM / OBEN + UNTEN

PA-500 ANTA B-10 (for glass 10 mm)
PA-500 ANTA B-12 (for glass 12 - 12,7 mm)
 ANTA INTERMEDIA B
 INTERMEDIATE PANEL B
 ZWISCHEN-SCHIEBEFLÜGEL B

ANTA C / DOOR C / TÜR C

PA-530 (x 2)

PA-532 (x 4)

SUPERIORE + INFERIORE
 / TOP + BOTTOM / OBEN + UNTEN

PA-500 ANTA C-10 (for glass 10 mm)
PA-500 ANTA C-12 (for glass 12 - 12,7 mm)
 ULTIMA ANTA C
 LAST PANEL C
 END-SCHIEBEFLÜGEL C

PA-500 PARK do-it-yourself

COME ASSEMBLARE LE ANTE / HOW TO ASSEMBLE THE DOORS / WIE DIE TÜREN ZUSAMMENSETZT WERDEN

TAGLIO PROFILI
PROFIL PREPARATION / PROFILBEARBEITUNG



KIT ACCESSORI
ACCESSORY SETS / ZUBEHÖR SETS



ANTA COMPLETA
COMPLETE DOOR / KOMPLETTE TÜR

PA-530 (x 2)



PA-532 (x 4)

SUPERIORE + INFERIORE
/ SUPERIORE + INFERIORE / SUPERIORE + INFERIORE

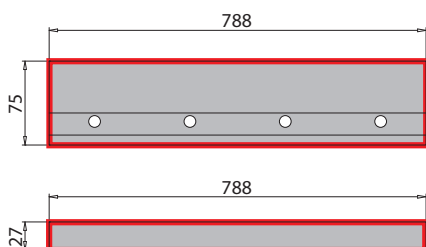

PA-500 ANTA D-10 (for glass 10 mm)
PA-500 ANTA D-12 (for glass 12 - 12,7 mm)
PORTA LATERALE D
LATERAL PIVOT DOOR D
DREH-SCHIEBEFLÜGEL D

PA-205 (x 1)



PA-523 (x 20)



PA-214
(max 4 mt)



PA-511 (x 4)



PA-225-10 (x 4)

PA-225-12 (x 4)



PA-206 (x 1)

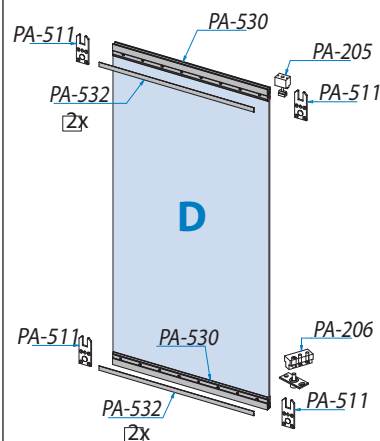

SCORREVOLI A PARCHEGGIO
SLIDING STACKING SYSTEMS

